

# Using Conduction Modes Basis Functions for Efficient Electromagnetic Analysis of On-Chip and Off-Chip Interconnect\*

Luca Daniel  
University of California,  
Berkeley  
dluca@eecs.berkeley.edu

Alberto  
Sangiovanni-Vincentelli  
Univ. of California, Berkeley  
alberto@eecs.berkeley.edu

Jacob White  
Massachusetts Institute of  
Technology  
white@mit.edu

## ABSTRACT

In this paper, we present an efficient method to model the interior of the conductors in a quasi-static or full-wave integral equation solver. We show how interconnect cross-sectional current distributions can be modeled using a small number of conduction modes as basis functions for the discretization of the Mixed Potential Integral Equation (MPIE). Two examples are presented to demonstrate the computational attractiveness of our method. In particular, we show how our new approach can successfully and efficiently capture skin effects, proximity effects and transmission line resonances.

## 1. INTRODUCTION

As integrated circuit frequencies keep increasing toward the GHz region, quasi-static and full-wave electromagnetic analysis is becoming progressively more important. In particular, Signal Integrity (SI) and Electro-Magnetic Interference (EMI) problems can often result in expensive post-prototype ad-hoc fixes and, sometimes, force the complete redesign of the system layout. In order to avoid these unpredictable additional costs and design time, it is desirable to address SI and EMI problems directly during design, for PCBs, packages, as well as IC's. In this paper, we address the most pressing task: the verification problem.

The past decade's intense development of accelerated integral equation solvers has made it possible to perform static and quasi-static electromagnetic analysis of packages or circuit boards with hundreds of conductors in just a few minutes on a workstation [1, 2, 3, 4]. The computational performance provided by these fast algorithms makes it now feasible to consider developing tools which can readily perform full-board analysis, for use in applications such as SI and EMI diagnosis and resolution.

If the application requires many fullwave analyses of entire PCBs or packages, reducing computation time will remain critical, and therefore minimizing the number of unknowns used for each conductor remains an important problem. The most common approach to minimizing the number of unknowns used to discretize on-chip and on-board interconnect is to make a thin conductor, or  $2\frac{1}{2}$ -D, approximation or a "skin-depth" approximation [5] using surface impedances. In addition, it has been recognized that the many conductor interiors can be decoupled into separate Helmholtz problems, which can then be combined with a global exterior Helmholtz problem [6, 7]. The many Helmholtz equations can then be solved either by integral or by differential methods. In this paper we take a somewhat different approach, and make use of the interior Helmholtz equation to generate basis functions for use in the standard Galerkin technique for solving the Mixed Potential Integral Equation (MPIE).

When solving the MPIE, in which the unknowns are conductor volume currents and surface charges, it is possible to tune the discretization to the problem by selecting basis functions which accurately represent the expected current flow and charge density. When discretizing relatively long and thin conductors, piecewise-constant basis functions are typically used [8]. The functions are generated by first chopping the long wires into a large number of sections that are short compared to the wavelength of the highest frequency of interest. Then, the surface of each section is covered with *panels*, each of which hold a constant charge density. To model current flow, the interiors of each conductor section is divided into a bundle of parallel *filaments*. Each filament carries a constant current density along its length. An example for a section of thin wire is shown in Figure 1. When modeling current crowding phenomena at high frequencies, such as skin effect and proximity effect, each conductor section must be discretized into filament bundles with a *very large* number of filaments.

\*This work was supported by the MARCO Interconnect Focus Center, by the Semiconductor Research Corporation, and by the Hewlett-Packard Company.

Permission to make digital or hard copies of all or part of this work for personal or classroom use is granted without fee provided that copies are not made or distributed for profit or commercial advantage and that copies bear this notice and the full citation on the first page. To copy otherwise, to republish, to post on servers or to redistribute to lists, requires prior specific permission and/or a fee.  
DAC 2001, June 18-22, 2001, Las Vegas, Nevada, USA.  
Copyright 2001 ACM 1-58113-297-2/01/0006 ...\$5.00.

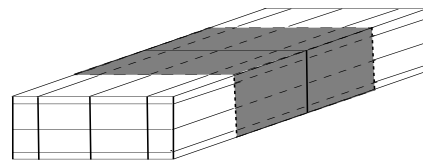

**Figure 1: Discretization of a short section of thin conductor. The volume is discretized into parallel filaments along the length. The conductor surface is discretized into panels shaded in gray.**

Even if sparsification techniques are used to solve the resulting system, the strong interaction between filaments in each conductor section must be resolved directly. The implication is that if  $n$  filaments are needed to properly represent current distribution in each conductor section, then the cost of even a fast solver will grow with  $n^2$ . For this reason, finding a different basis which uses fewer functions to represent current distribution in each conductor section can have a significant impact on solver speed.

## 2. CONDUCTION MODES

Combining the two curl Maxwell differential equations, and using the “good conductor hypothesis”,  $\sigma \gg j\omega\epsilon$ , we obtain the governing Helmholtz diffusion equation for the region inside each conductor:  $\nabla \times \nabla \times \mathbf{E} + j\omega\mu\sigma\mathbf{E} = 0$ . In terms of the current density,  $\mathbf{J}$ , and of the skin depth,  $\delta = \sqrt{2/(\omega\mu\sigma)}$ , we have  $\nabla \times \nabla \times \mathbf{J} + \left(\frac{1+j}{\delta}\right)^2 \mathbf{J} = 0$ . Assuming the current in each conductor section flows primarily lengthwise,  $\mathbf{J}$  can be approximated by  $\mathbf{J} = J_z \hat{\mathbf{a}}_z$ , where  $\hat{\mathbf{a}}_z$  points along the conductor length. The scalar  $J_z$  then satisfies

$$\frac{\partial^2 J_z}{\partial x^2} + \frac{\partial^2 J_z}{\partial y^2} - \left(\frac{1+j}{\delta}\right)^2 J_z = 0. \quad (1)$$

The general solution of (1) is the infinite series:

$J_z(x, y) = \sum_{\nu} C_{\nu} e^{-\psi_{\nu} x} e^{-\eta_{\nu} y}$ , where  $C_{\nu}$  are free coefficients and  $\psi_{\nu}$  and  $\eta_{\nu}$  satisfy  $\psi_{\nu}^2 + \eta_{\nu}^2 = \left(\frac{1+j}{\delta}\right)^2$ . Each term in the previous series is referred to as a “conduction mode” [9]. As an illustrative example of a very simple conduction mode, let us choose  $\psi_{\nu} = \frac{1+j}{\delta}$  and  $\eta_{\nu} = 0$ . This mode can account for cross-sectional current distributions decaying exponentially as  $1/\delta$  from the edge of the conductor cross-section. The picture on the left in Fig. 2 shows a graphical representation of such current distribution.

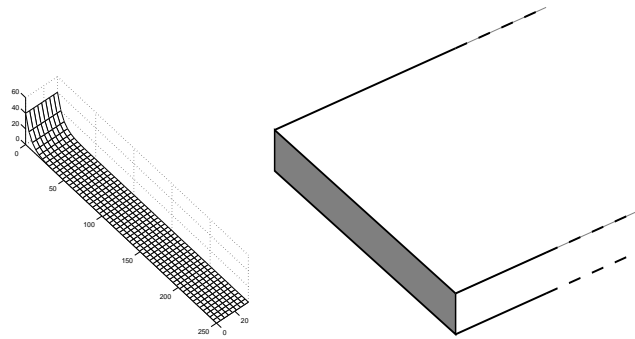

**Figure 2: Current density for an “edge mode” (on the left) associated with the shaded rectangular cross-section (on the right).**

For current distributions generated by interconnect problems,  $J_z$  can be accurately represented using only a few conduction modes. For example, a combination of four simple edge modes, one for each edge, can account for most of the high frequency cross-sectional conductor current distribution. At very high frequency, a few other modes might be needed to account for corner effects. The simplest example of corner mode is obtained by choosing  $\psi_{\nu} = \eta_{\nu} = \frac{1}{\sqrt{2}} \left(\frac{1+j}{\delta}\right)$ . As it is shown in the picture on the left in Fig. 3, this mode can easily account for a cross-sectional current distribution decaying exponentially from the corner of the conductor cross-section.

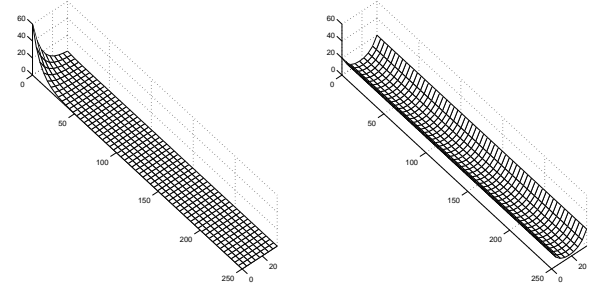

**Figure 3: On the left: “corner mode” for a rectangular cross-section. On the right: example of a single basis function obtained combining two horizontal edge modes.**

## 3. CROSS-SECTION BASIS FUNCTIONS

Let the cross-sectional current density be represented by a collection of global basis functions:  $\mathbf{J}(\mathbf{r}) = \sum_{j,k} I_{jk} \mathbf{w}_{jk}(\mathbf{r})$ , where  $j$  is a summation index over all the pieces of conductors, and  $k$  is a summation index over all the basis functions chosen for each piece. The conduction modes presented in the previous section can represent a natural choice for our global basis functions:

$$\mathbf{w}_{jk}(\mathbf{r}) = \begin{cases} \frac{\hat{\mathbf{a}}_z}{A_{jk}} \sum_{\nu} e^{\pm\psi_{jk\nu}(x-x_{jk\nu})} e^{\pm\eta_{jk\nu}(y-y_{jk\nu})} & \text{if } \mathbf{r} \in V_j \\ 0 & \text{otherwise} \end{cases} \quad (2)$$

where  $x$  and  $y$  are variables spanning the cross-section of conductor piece  $j$ , and refer to one of its corners:  $\mathbf{r} = \mathbf{r}_{j\text{corner}} + x\hat{\mathbf{a}}_{x_j} + y\hat{\mathbf{a}}_{y_j}$ . Translation constants  $x_{jk\nu}$ ,  $y_{jk\nu}$ , and “plus” signs in front of  $\psi_{jk\nu}$  and  $\eta_{jk\nu}$  account for modes decaying from the other corners or edges. We have chosen to introduce a normalization constant  $A_{jk}$  defined such that parameter  $I_{jk}$  represents the part of the current on the cross-section associated with basis function  $\mathbf{w}_{jk}$ :  $A_{jk} = \int_{S_j} \sum_{\nu} e^{\pm\psi_{jk\nu}(x-x_{jk\nu})} e^{\pm\eta_{jk\nu}(y-y_{jk\nu})} dx dy$ . In some cases, such as when building Reduced Order Models (ROM), it is possible and convenient to also pre-orthogonalize our set of basis functions.

To reduce the number of degrees of freedom for the discretization, it is possible to “pair-up”, into a single basis function, modes which are likely to have the same magnitude. One example where the combination of two modes into a single basis function is helpful is in modeling a PCB trace. In this case, one may wish to combine the lower horizontal edge mode with the upper horizontal edge mode into one single basis function, as shown in the picture on the right in Fig. 3. In fact, the very large aspect ratio of the PCB cross-section traces, and the relative large separation between layers, typically do not allow significant proximity effect differences between lower and upper horizontal edge modes. Large differences, instead, can often be observed between any modes on opposite lateral sides (left to right), due to proximity effects. For this reason, the two lateral edge modes should instead be assigned to two separate basis functions.

## 4. A TRANSMISSION LINE EXAMPLE

In this example, we tested the ability of our method to capture transmission line phenomena such as impedance resonances. We modeled two PCB traces, 30cm long, very close together in a coplanar transmission line configuration. Traces are  $250\mu\text{m}$  wide,  $35\mu\text{m}$  thick and  $150\mu\text{m}$  far apart.

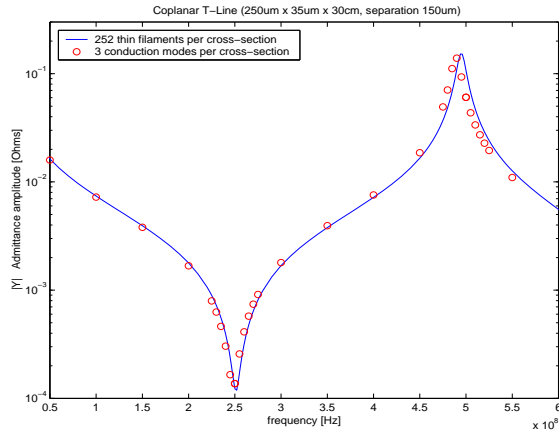

**Figure 4: Admittance amplitude vs. frequency for a shorted coplanar T-line. The continuous line is obtained using a very fine 252 thin filaments per cross-section discretization. The circles are the results obtained using only 3 conduction modes per cross-section.**

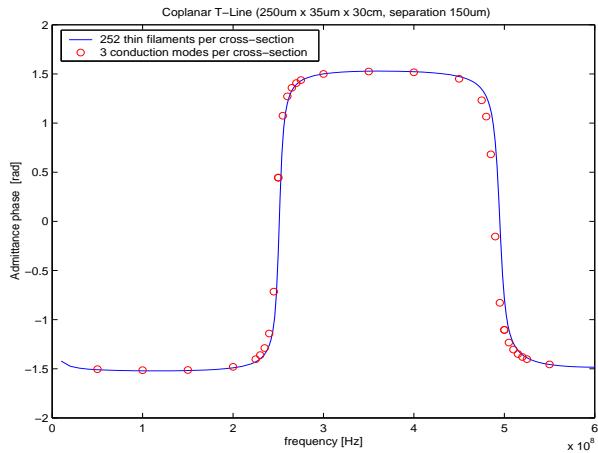

**Figure 5: Admittance phase vs. frequency for the same coplanar T-line as in Fig. 4.**

Worst case high-Q resonances are obtained when the two traces are shorted at one end, and are excited on the other end at some special frequencies with an ideal voltage source. For instance, when the frequency is such that the transmission line length is close to a quarter of a wavelength or to half a wavelength, one can observe in Fig. 4 and 5 resonance peaks. Such peaks are typically difficult to simulate with accuracy since they are very much influenced by the internal current distribution on the conductors. Continuous lines in Fig. 4 and 5 are obtained using a classical piece-wise constant very fine cross-sectional discretization of 252 thin filaments per cross-section. This kind of discretization is sufficient to consider those continuous lines the “exact” solution. Circles are obtained instead using only three conduction modes per wire cross-section: two lateral edge-modes basis functions as on Fig. 2 (left), and one combined horizontal modes basis function as in Fig. 3 (right). Both in the thin filaments method and in our conduction modes method, we subdivided each trace along its length into pieces short compared to a wavelength.

In Fig. 5, we measure that our three conduction modes method gives a worst case 1.3% error in the position of the second half-wavelength admittance resonance. A higher worst case error (9.6%) is measured on the amplitude of the same resonance. Fig. 6 compares at such resonance frequency the current distributions on the cross-section of one of the traces. On the left we show the result from the very fine 252 thin filaments discretization. On the right we show our three conduction modes solution. One can observe that the two current distributions are very much alike, except for the corners. At this frequency, currents begin to crowd more significantly on the corners of the cross-section, requiring the inclusion of a few “corner modes” in the set of the discretization basis functions, if higher accuracies are needed.

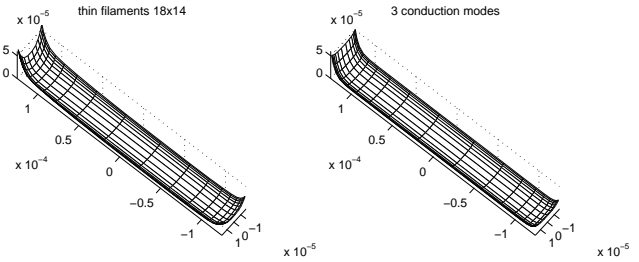

**Figure 6: Cross sectional current distributions at the half-wavelength resonance. On the left: result from a very fine cross-sectional discretization. On the right: result from the 3 “edge” conduction modes per cross-section method. Inclusion of corners modes can farther improve the fit if higher accuracies are needed.**

## 5. AN IC BUS EXAMPLE

In a second example, we tested the ability of our method to model skin effects and proximity effects on an IC bus example shown in Fig. 7. Six interconnect wires are routed very close to each other ( $2\mu\text{m}$ ) for a long path. Each wire is  $2\mu\text{m}$  wide and  $2.5\mu\text{m}$  thick, presenting a completely different cross-sectional aspect ratio from the previous PCB trace example. The six wires are routed in a dog-leg bus configuration, where the three sections are  $100\mu\text{m}$ ,  $200\mu\text{m}$  and  $50\mu\text{m}$  long respectively. The four wires in the center of Fig. 7 are signal wires. The first and last wire are instead ground return wires. In our experiment, we grounded on one side the second wire from the right in Fig. 7, and we drove the other side with an ideal voltage source.

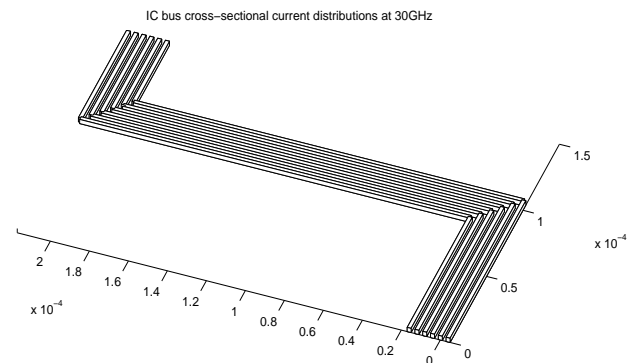

**Figure 7: IC bus: 4 signal wires between two ground return wires.**

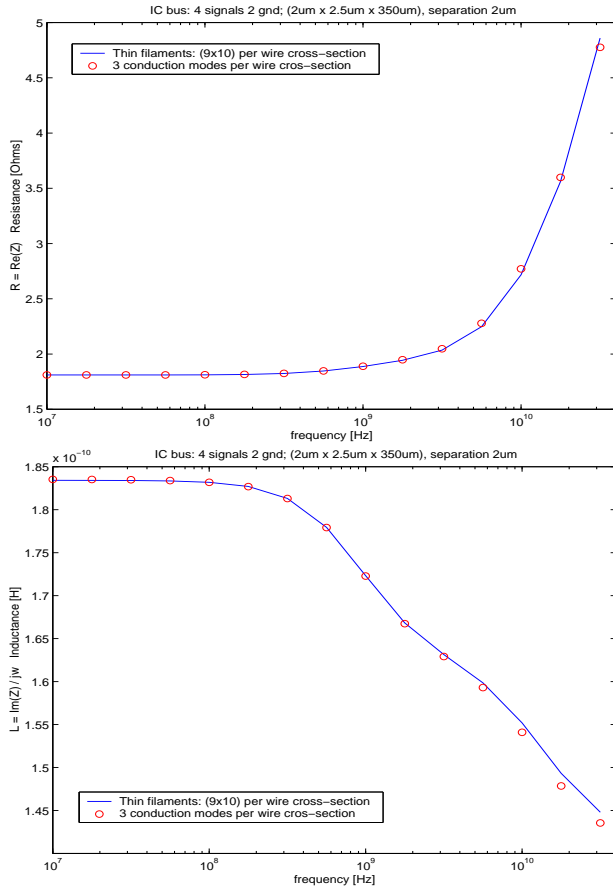
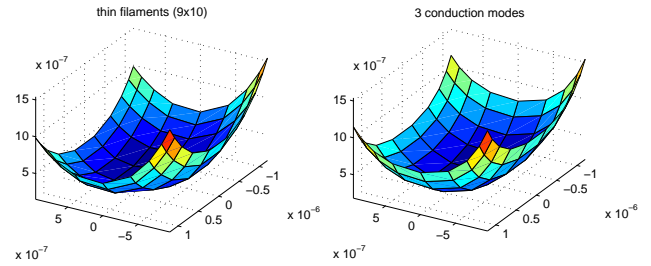

**Figure 8:**  $Re\{Z\}$  (above) and  $L = Im\{Z\}/j\omega$  (below) vs. frequency for bus in Fig 7. The continuous lines are obtained using a very fine thin filament discretization with 90 filaments per wire cross-section. Circles show the results obtained using only three conduction modes.

Fig. 8 shows the resistive part (above) of the impedance as a function of frequency, as well as  $L = Im\{Z\}/(j\omega)$ , the “inductive” part of the impedance (below). The continuous lines are obtained using a very fine piece-wise constant thin filament discretization with 90 filaments per wire cross-section. These 90 filaments are sufficient to consider the continuous lines in Fig. 8 as the “exact” solution. Circles show the results obtained using only three conduction modes. In the worst case, our three conduction modes give an error of 1.5% in the resistive part of the impedance, and 0.9% in the inductive part of the impedance.

In Fig. 9, we compare for a worst case 30GHz harmonics, the cross-sectional current density on the driven wire. On the left we show the result from the very fine thin filament discretization. On the right we show the result obtained using only 3 conduction modes per cross-section. Comparing such figures, we observe that our method captures accurately both skin effects and proximity effects.

In a different experiment on the same IC bus example, we finally observed that for the same final 1.5% accuracy, the classical method would require at least 49 thin filaments per cross-section when used in an optimal way, with smaller filaments near edges and corners. Therefore, in this example, we conclude that our approach requires 16 times fewer parameters than the classical method for the same final accuracy.



**Figure 9:** Comparison for the cross-sectional current density on the driven bus wire. On the left we show the result from a very fine thin filament discretization. On the right we show the result obtained using only 3 conduction modes per cross-section.

## 6. CONCLUSIONS

In this paper, we have presented a new method for modeling internal conductor current distributions in a quasi-static or full-wave electromagnetic simulator. We have shown how to derive conduction modes for use in the discretization of the Mixed Potential Integral Equation. We have demonstrated the method on two examples, an IC bus and a shorted transmission line example. We showed that skin effects, proximity effects and transmission line resonances can all be successfully and efficiently captured for different wire configurations and cross-sectional aspect ratios. In our examples, for the same final accuracies, using our conduction modes method, linear systems of equations are obtained 16 to 23 times smaller than when using the classical thin filament discretization methods.

## 7. REFERENCES

- [1] K. Nabors and J. White. Fastcap: a Multipole Accelerated 3-D Capacitance Extraction Program. In *IEEE Trans. on Computer-Aided Design*, pages 1447–59, November 1991.
- [2] S. Kapur and D. Long. Large Scale Capacitance Calculations with Nebula. In *Design Automation Conference*, June 2000.
- [3] J. Tausch and J. White. A Multiscale Method for Fast Capacitance Extraction. In *Design Automation Conference*, June 1999.
- [4] M. Kamon, M. J. Tsuk, and J. White. Fasthenry: A Multipole-Accelerated 3-D Inductance Extraction Program. *IEEE Trans. on Microwave Theory and Techniques*, September 1994.
- [5] E. Tuncer, B. T. Lee, and D. P. Neikirk. Interconnect Series Impedance Determination Using a Surface Ribbon Method. *IEEE Topical Meeting on Electrical Performance of Electronic Packaging*, pages 250–252, November 1994.
- [6] K. M. Coperich, A. E. Ruehli, and A. Cangellaris. Enhanced Skin Effect for Partial-Element Equivalent-Circuit (PEEC) Models. *IEEE Trans. on Microwave Theory and Techniques*, 48(9):1435–42, September 2000.
- [7] J. Wang, J. Tausch, and J. White. A Wide Frequency Range Surface Integral Formulation for 3-D RLC Extraction. In *IEEE Internat. Conf. on Computer-Aided Design*, pages 456–460, 1997.
- [8] A. E. Ruehli. Equivalent Circuit Models for Three Dimensional Multiconductor Systems. *IEEE Trans. on Microwave Theory and Techniques*, 22:216–221, March 1974.
- [9] E. M. Deeley. Surface Impedance near Edges and Corners in Three-Dimensional Media. *IEEE Trans. on Magnetics*, 2:712–714, 1990.